

# PRODUCT SHEET

## Description:

Soft Close Hinge "Klap II", Wall/Glass, SS-304, Brushed, 8-14 mm, Back Plate, Brushed, Max Door Weight: 60KG, Max Door Height 2400mm, Max Door Width: 1000mm, Self-Closing at 85DG., Hold-Open at 90DG, Max Door Angle 95DG., Tested According to EN1154

## Item number:

15.24.280-0

Units	Box	Carton	HS Code	Barcode
Pair	1	6	8302100090	 5704866478212

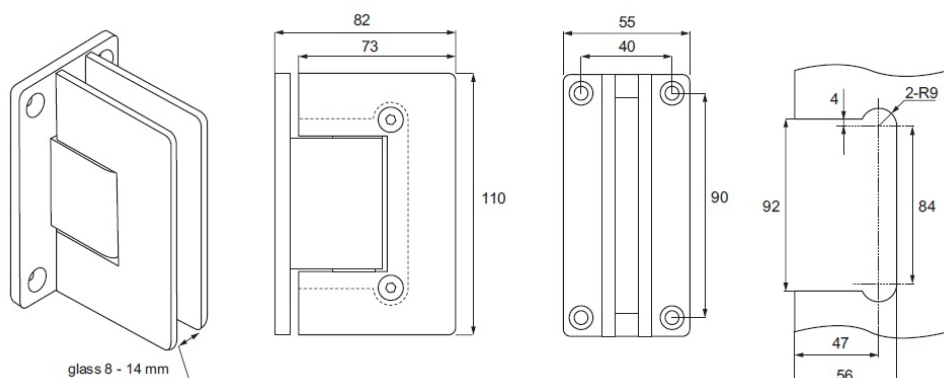

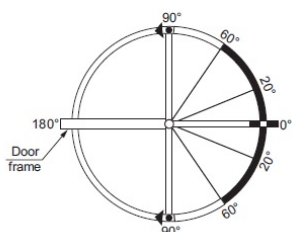
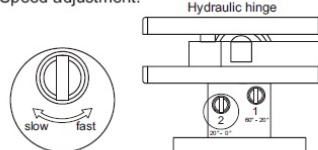

### Speed adjustment:



### Features:

1. Soft closing: 20° - 0° (adjust by valve 2)
2. Soft closing: 60° - 20° (adjust by valve 1)
3. Fast closing: 90° - 60°
4. HO (Hold-open: 95° - 90°)

NH (No hold open)

-  Soft closing section
-  Fast closing section
-  Hold-open section

## SISO A/S

Mileparken 11  
DK-2740 Skovlunde  
Denmark  
VAT: DK 24786013

Phone +45 45 830 900

[www.siso.dk](http://www.siso.dk)  
[siso@siso.dk](mailto:siso@siso.dk)

Danske Bank  
Nytorv Branch  
Copenhagen  
SWIFT: DABADKKK

Account no.  
4180 3112 112936  
IBAN Account  
DK7230003112112936